

SMCJ Series

Description

The SMC series is designed to protect voltage sensitive components from high voltage, high energy transients. They have excellent clamping capability, high surge capability, low zener impedance and fast response time. The SMC series is supplied in YINT Semiconductor's exclusive, cost-effective, highly reliable and is ideally suited for use in communication systems, automotive, numerical controls, process controls, medical equipment, business machines, power supplies and many other industrial/consumer Applications.

Features

- Case: DO-214AB/SMC
- For surface mounted applications in order to optimize board space.
- 1500 W peak pulse power capability with a 10/1000 μ s waveform
- Typical failure mode is short from over-specified voltage or current
- High Temperature soldering: 260°C/10 seconds at terminals.
- IEC61000-4-2 (ESD) \pm 30kV (air), \pm 30kV (contact).



Functional Diagram

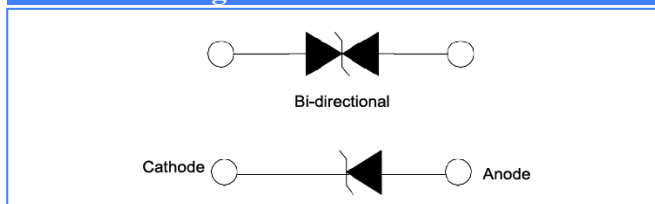

Applications

TVS devices are ideal for the protection of I/O Interfaces, V_{CC} bus and other vulnerable circuits used in Telecom, Computer, Industrial and Consumer electronic applications.

Maximum Ratings (TA=25°C unless otherwise noted)

Parameter	Symbol	Value	Unit
Peak Pulse Power Dissipation by 10/1000 μ s Waveform <small>(note1 note 2)</small>	P_{PK}	1500	Watts
Peak Forward Surge Current 8.3 ms Single Half Sine Wave Superimposed on Rated Load (JEDEC Method) (Note 3)	I_{FSM}	200	Amps
Steady State Power Dissipation @ $T_L = 50^\circ C$	$P_{M(AV)}$	6.5	Watts
Maximum Instantaneous Forward Voltage @ $I_{PP} = 50 A$ (For Unidirectional Units Only)	V_F	3.5/5	Volts
Operating Temperature Range	T_J	-55 to +150	$^\circ C$
Storage Temperature Range	T_{STG}	-55 to +150	$^\circ C$

NOTES:

1. Non-repetitive current pulse, per Pulse Waveform graph and derated above $T_A = 25^\circ C$ per Pulse Derating Curve.
2. Thermal Resistance Junction to Lead.
3. 8.3 ms Single Half-Sine Wave duty cycle = 4 pulses maximum per minute (unidirectional units only).

Electrical Characteristics (TA = 25 °C unless otherwise noted)

Part Number (Bi)	Part Number (Uni)	MARKING		Reverse Stand off Voltage V _R (Volts)	Breakdown Voltage V _{BR} (Volts)@I _T		Test Current I _T (mA)	Maximum Reverse Leakage I _R @ V _R (μA)	Maximum Peak Pulse Current I _{pp} (A)	Maximum Clamping Voltage V _C @ I _{pp} (V)
		BI	UNI		Min .V	Max .V				
SMCJ5.0CA	SMCJ5.0A	BDE	GDE	5.0	6.40	7.00	10	800	163.0	9.2
SMCJ6.0CA	SMCJ6.0A	BDG	GDG	6.0	6.67	7.37	10	800	145.6	10.3
SMCJ6.5CA	SMCJ 6.5A	BDK	GDK	6.5	7.22	7.90	10	500	134.0	11.2
SMCJ7.0CA	SMCJ7.0 A	BDM	GDM	7.0	7.78	8.60	10	200	125.0	12.0
SMCJ7.5CA	SMCJ 7.5A	BDP	GDP	7.5	8.33	9.21	1	100	116.3	12.9
SMCJ8.0CA	SMCJ 8.0A	BDR	GDR	8.0	8.89	9.83	1	50	110.3	13.6
SMCJ8.5CA	SMCJ8.5 A	BDT	GDT	8.5	9.44	10.40	1	20	104.2	14.4
SMCJ9.0CA	SMCJ9.0 A	BDV	GDV	9.0	10.00	11.10	1	10	97.4	15.4
SMCJ10CA	SMCJ10A	BDX	GDX	10.0	11.10	12.30	1	5	88.3	17.0
SMCJ11CA	SMCJ11A	BDZ	GDZ	11.0	12.20	13.50	1	1	82.5	18.2
SMCJ12CA	SMCJ12A	BEE	GEE	12.0	13.30	14.70	1	1	75.4	19.9
SMCJ13CA	SMCJ13A	BEG	GEG	13.0	14.40	15.90	1	1	69.8	21.5
SMCJ14CA	SMCJ14A	BEK	GEK	14.0	15.60	17.20	1	1	64.7	23.2
SMCJ15CA	SMCJ15A	BEM	GEM	15.0	16.70	18.50	1	1	61.5	24.4
SMCJ16CA	SMCJ16A	BEP	GEP	16.0	17.80	19.70	1	1	57.7	26.0
SMCJ17CA	SMCJ17A	BER	GER	17.0	18.90	20.90	1	1	54.4	27.6
SMCJ18CA	SMCJ18A	BET	GET	18.0	20.00	22.10	1	1	51.4	29.2
SMCJ20CA	SMCJ20A	BEV	GEV	20.0	22.20	24.50	1	1	46.3	32.4
SMCJ22CA	SMCJ22A	BEX	GEX	22.0	24.40	26.90	1	1	42.3	35.5
SMCJ24CA	SMCJ24A	BEZ	GEZ	24.0	26.70	29.50	1	1	38.6	38.9
SMCJ26CA	SMCJ26A	BFE	GFE	26.0	28.90	31.90	1	1	35.7	42.1
SMCJ28CA	SMCJ28A	BFG	GFG	28.0	31.10	34.40	1	1	33.1	45.4
SMCJ30CA	SMCJ30A	BFK	GFK	30.0	33.30	36.80	1	1	31.0	48.4
SMCJ33CA	SMCJ33A	BFM	GFM	33.0	36.70	40.60	1	1	28.2	53.3
SMCJ36CA	SMCJ36A	BFP	GFP	36.0	40.00	44.20	1	1	25.9	58.1
SMCJ40CA	SMCJ40A	BFR	GFR	40.0	44.40	49.10	1	1	23.3	64.5
SMCJ43CA	SMCJ43A	BFT	GFT	43.0	47.80	52.80	1	1	21.7	69.4
SMCJ45CA	SMCJ45A	BFV	GFV	45.0	50.00	55.30	1	1	20.6	72.7
SMCJ48CA	SMCJ48A	BFX	GFX	48.0	53.30	58.90	1	1	19.4	77.4
SMCJ51CA	SMCJ51A	BFZ	GFZ	51.0	56.70	62.70	1	1	18.2	82.4
SMCJ54CA	SMCJ54A	BGE	GGE	54.0	60.00	66.30	1	1	17.3	87.1
SMCJ58CA	SMCJ58A	BGG	GGG	58.0	64.40	71.20	1	1	16.1	93.6
SMCJ60CA	SMCJ60A	BGK	GGK	60.0	66.70	73.70	1	1	15.5	96.8
SMCJ64CA	SMCJ64A	BGM	GGM	64.0	71.10	78.60	1	1	14.6	103.0
SMCJ70CA	SMCJ70A	BGP	GGP	70.0	77.80	86.00	1	1	13.3	113.0

Part Number (Bi)	Part Number (Uni)	MARKING		Reverse Stand off Voltage V_R (Volts)	Breakdown Voltage V_{BR} (Volts)@ I_T		Test Current I_T (mA)	Maximum Reverse Leakage I_R @ V_R (μ A)	Maximum Peak Pulse Current I_{pp} (A)	Maximum Clamping Voltage V_C @ I_{pp} (V)
		BI	UNI		Min .V	Max .V				
SMCJ75CA	SMCJ75A	BGR	GGR	75.0	83.30	92.10	1	1	12.4	121.0
SMCJ78CA	SMCJ78A	BGT	GGT	78.0	86.70	95.80	1	1	11.9	126.0
SMCJ85CA	SMCJ85A	BGV	GGV	85.0	94.4	104.0	1	1	11.0	137.0
SMCJ90CA	SMCJ90A	BGX	GGX	90.0	100.0	111.0	1	1	10.3	146.0
SMCJ100CA	SMCJ100A	BGZ	GGZ	100.0	111.0	123.0	1	1	9.3	162.0
SMCJ110CA	SMCJ110A	BHE	GHE	110.0	122.0	135.0	1	1	8.5	177.0
SMCJ120CA	SMCJ120A	BHG	GHG	120.0	133.0	147.0	1	1	7.8	193.0
SMCJ130CA	SMCJ130A	BHK	GHK	130.0	144.0	159.0	1	1	7.2	209.0
SMCJ150CA	SMCJ150A	BHM	GHM	150.0	167.0	185.0	1	1	6.2	243.0
SMCJ160CA	SMCJ160A	BHP	GHP	160.0	178.0	197.0	1	1	5.8	259.0
SMCJ170CA	SMCJ170A	BHR	GHR	170.0	189.0	209.0	1	1	5.5	275.0
SMCJ180CA	SMCJ180A	BHT	GHT	180.0	201.0	222.0	1	1	5.1	292.0
SMCJ190CA	SMCJ190A	BHU	GHU	190.0	211.0	233.0	1	1	4.8	308.0
SMCJ200CA	SMCJ200A	BHV	GHV	200.0	224.0	247.0	1	1	4.6	324.0
SMCJ210CA	SMCJ210A	BHW	GHW	210.0	237.0	263.0	1	1	4.4	340.0
SMCJ220CA	SMCJ220A	BHX	GHX	220.0	246.0	272.0	1	1	4.2	356.0
SMCJ250CA	SMCJ250A	BHZ	GHZ	250.0	279.0	309.0	1	1	3.7	405.0
SMCJ300CA	SMCJ300A	BJE	GJE	300.0	335.0	371.0	1	1	3.1	486.0
SMCJ350CA	SMCJ350A	BJG	GJG	350.0	391.0	432.0	1	1	2.6	567.0
SMCJ400CA	SMCJ400A	BJK	GJK	400.0	447.0	494.0	1	1	2.3	648.0
SMCJ440CA	SMCJ440A	BJM	GJM	440.0	492.0	543.0	1	1	2.1	713.0

I-V Curve Characteristics

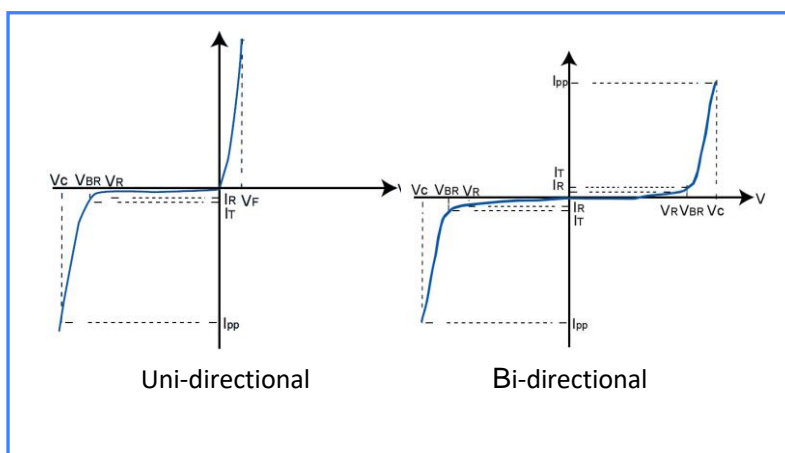

Symbol	Parameter
I_{PP}	Maximum Reverse Peak Pulse Current
V_C	Clamping Voltage @ I_{PP}
V_{RWM}	Working Peak Reverse Voltage
I_R	Maximum Reverse Leakage Current @ V_{RWM}
V_{BR}	Breakdown Voltage @ I_T (Test Current)

Rating & Characteristic Curves

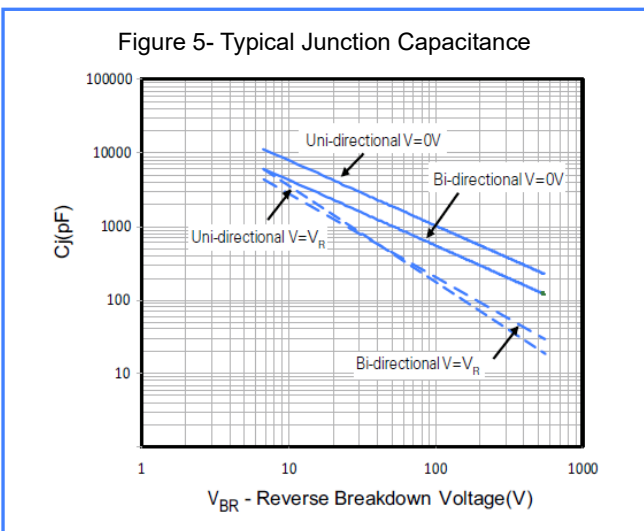
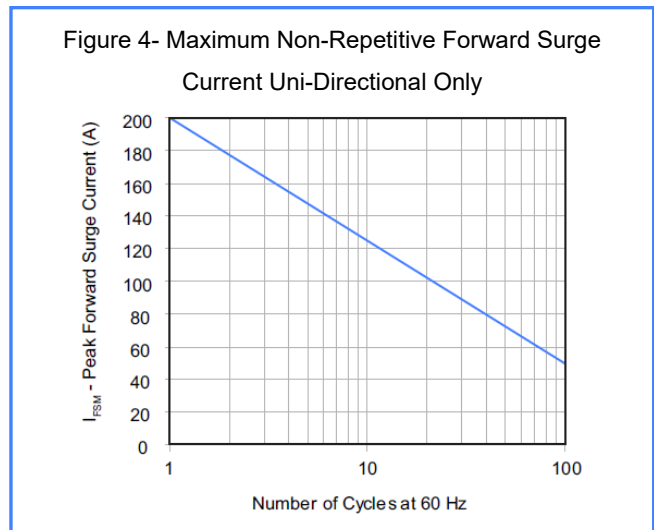
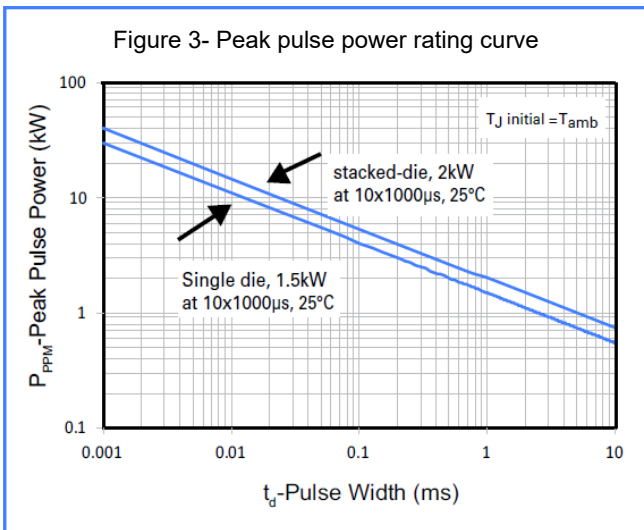
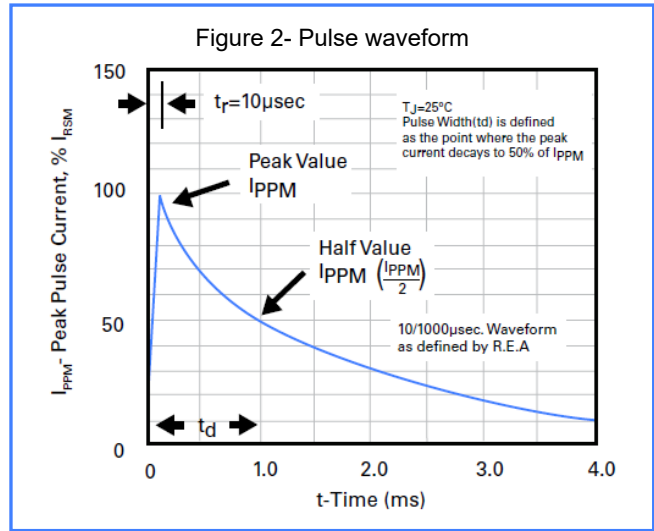
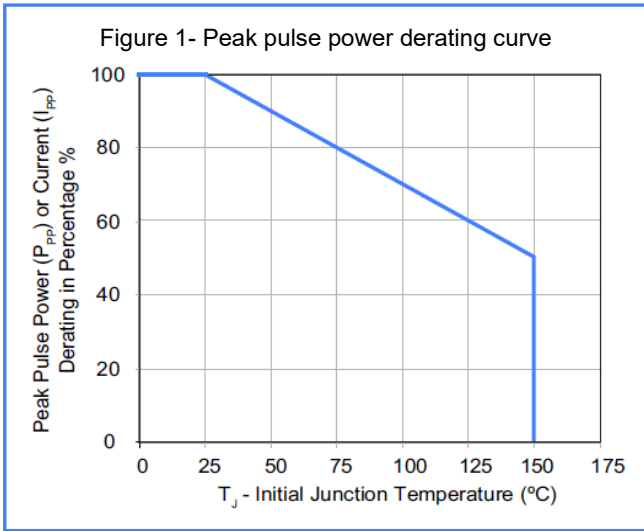

Soldering Parameters

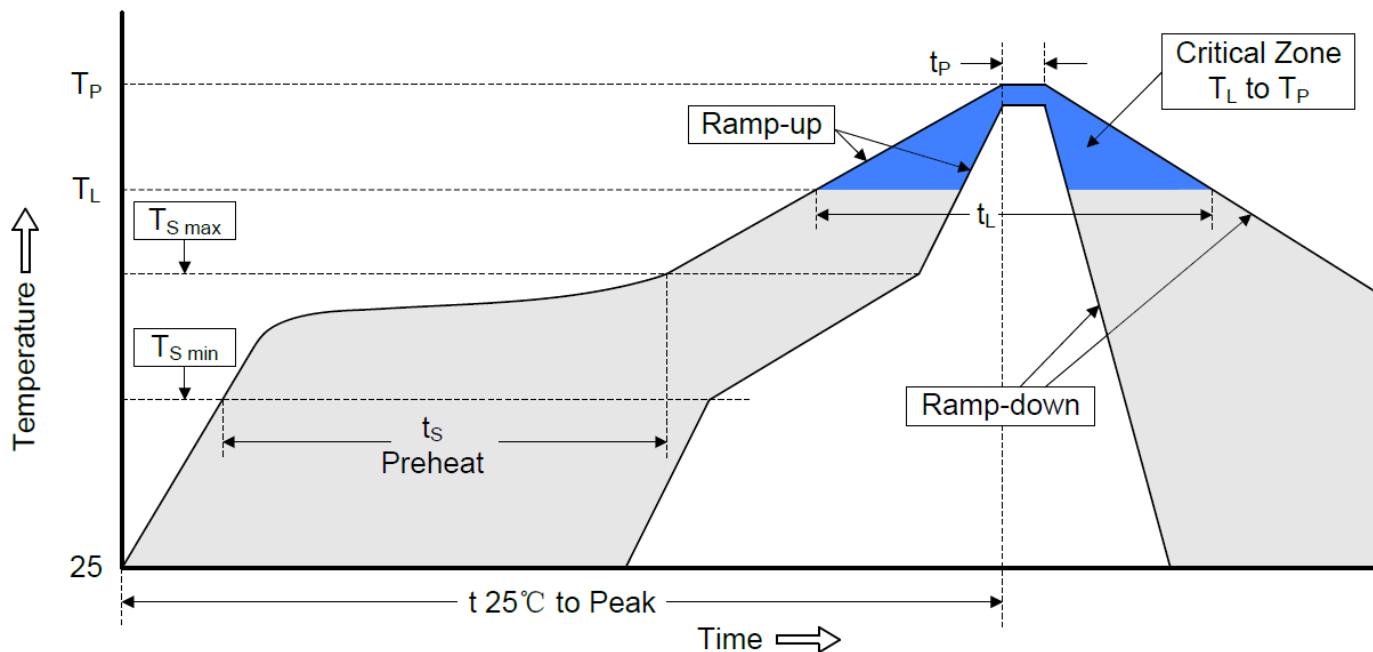

Profile Feature	Pb-Free Assembly
Average ramp-up rate (T_L to T_P)	3°C/second max.
Preheat	
-Temperature Min ($T_{S\ min}$)	150°C
-Temperature Max ($T_{S\ max}$)	200°C
-Time (min to max)(t_s)	60-180 seconds
$T_{S\ max}$ to T_L	
-Ramp-up Rate	3°C/second max.
Time maintained above:	
- Temperature (T_L)	217°C
- Time (t_L)	60-150 seconds
Peak Temperature (T_P)	260°C
Time within 5°C of actual Peak Temperature (t_P)	20-40 seconds
Ramp-down Rate	6°C /second max.
Time 25°C to Peak Temperature	8 minutes max.

PACKAGE OUTLINE DIMENSIONS in inches (millimeters)

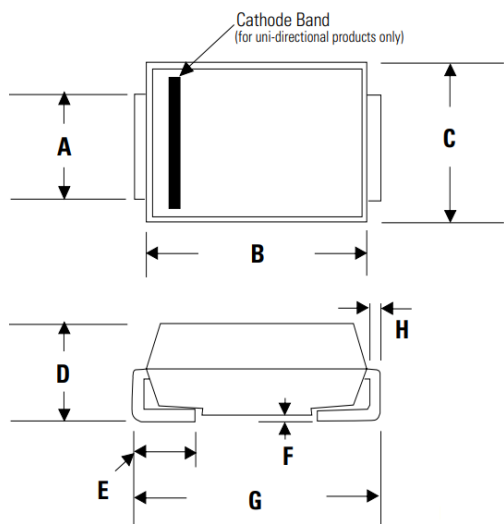

Mounting Pad Layout

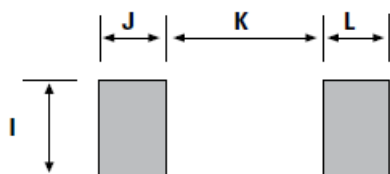

Dimensions	Millimeter	
	Min	Max
A	2.900	3.200
B	6.600	7.110
C	5.590	6.220
D	2.060	2.830
E	0.760	1.520
F	-	0.203
G	7.750	8.130
H	0.152	0.305
I	3.300	-
J	2.400	-
K	-	4.200
L	2.400	-

Part Number Code & Marking Code

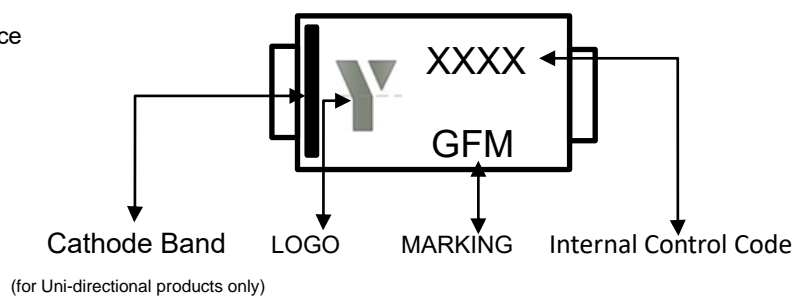
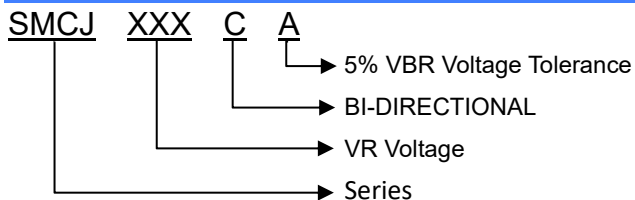

Disclaimer

Specifications are subject to change without notice.
The device characteristics and parameters in this data sheet can and do vary in different applications and actual device performance may vary over time.
Users should verify actual device performance in their specific applications.